

The HERS Associate and Taking the Performance Path

Module 2 – Cracking the Building Energy Code

Presented by:
Mike Barcik



EEBA

VIRTUAL HIGH PERFORMANCE
HOME SUMMIT 2020

SEPT 29 - OCT 9 | ONLINE VIA WHOVA



About EEBA



EEBA

For over 35 years, EEBA has provided the most trusted resources for building science information and education in the construction industry. EEBA delivers turn-key educational resources and events designed to transform residential construction practices through high performance design, marketing, materials, and technologies. Through our educational events, annual Summit and various publications and resources, EEBA reaches thousands of key decision makers and other important industry players each year.

Boy, the sacrifices I make for EEBA...

Squirrel !!!



VIRTUAL HIGH PERFORMANCE
HOME SUMMIT 2020

EEBA

SEPT 29 - OCT 9 | ONLINE VIA WHOVA



Introductions



Mike Barcik – Technical Principal
• mikeb@southface.org



About Southface

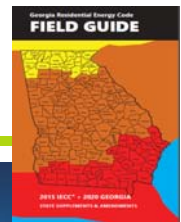

- *Building a Regenerative Economy, Responsible Resource Use & Social Equity Through a Healthy Built Environment for All*

www.southface.org



AIA CES-approved course

- EEBA is a registered provider of AIA-approved continuing education under Provider Number G138. All registered AIA CES Providers must comply with the AIA Standards for Continuing Education Programs. Any questions or concerns about this provider or this learning program may be sent to AIA CES (cessupport@aia.org or (800) AIA 3837, Option 3).
- This learning program is registered with AIA CES for continuing professional education. As such, it does not include content that may be deemed or construed to be an approval or endorsement by the AIA of any material of construction or any method or manner of handling, using, distributing, or dealing in any material or product.



Poll: Who Are You?

AIA
Continuing
Education
Provider

5

Module Learning Objectives

- Understand how building science influences the energy code
- Know the prescriptive R-values for components
- Learn mandatory code requirements
- Comprehend the trade-off compliance options to the prescriptive code



6

The house as a system

A house is a system made up of interrelated parts:

- The weather barrier
- Lighting & appliances & plumbing
- The site and neighboring homes
- The building thermal envelope
- Space conditioning
- Ventilation



- All efficiency measures should take occupants into account (e.g., air sealing & ventilation)

7

Building Science:

- Employ scientific principles from a variety of fields that govern building performance
- Optimize building performance and understand, predict, prevent and correct building failures
- Systems approach to houses
- Physics of:
 - **Heat:**
Flows from hot to cold
 - **Air:**
Flows from high pressure to low
 - **Moisture:**
Flows from wet to dry (liquid and vapor)

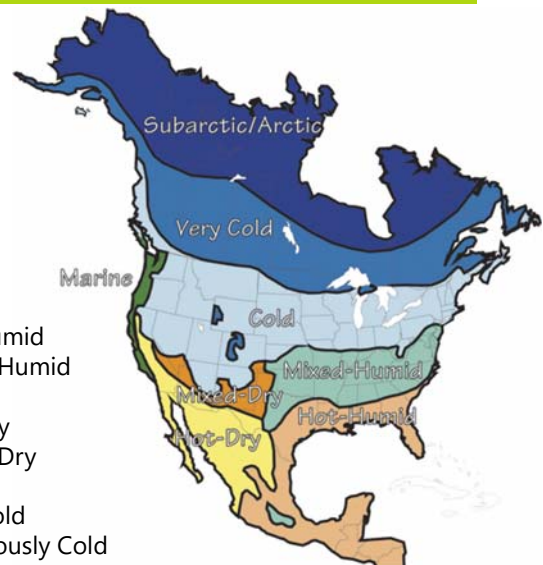

- A. Hot-Humid
- B. Mixed-Humid
- C. Cold
- D. Hot-Dry
- E. Mixed-Dry
- F. Marine
- G. Very Cold
- H. Ridiculously Cold



8

Question 1

In your opinion, what percentage of a home's total energy is used for space heating and cooling?

- A. < 20%
- B. Between 20 & 50%
- C. More than 50%



9

Home Energy Usage Over Time

-Shrink the pie!

-Usage shifts

Total energy use in homes

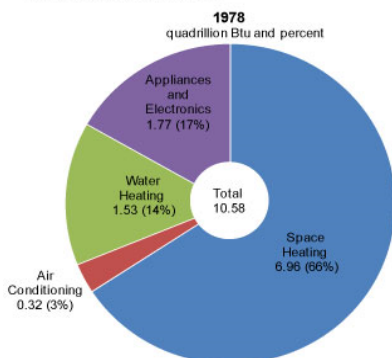

Source: U.S. Energy Information Administration, 1978 and 2005

Energy consumption in homes by end uses
quadrillion Btu and percent

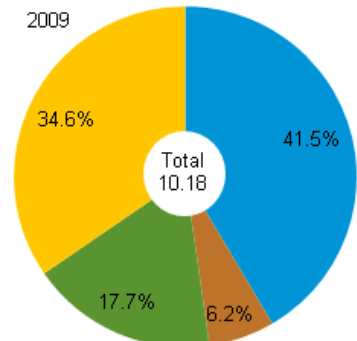
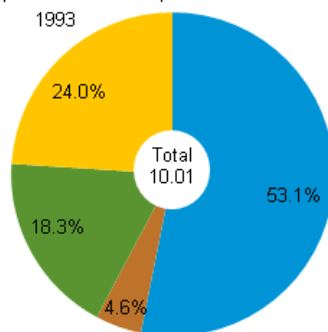

■ space heating ■ air conditioning ■ water heating ■ appliances, electronics, and

Source: U.S. Energy Information Administration, Residential Energy Consumption Survey.
Note: Amounts represent the energy consumption in occupied primary housing units.



10

Home Energy Usage Breakdown

Residential electricity consumption by end use, 2015
percent of total

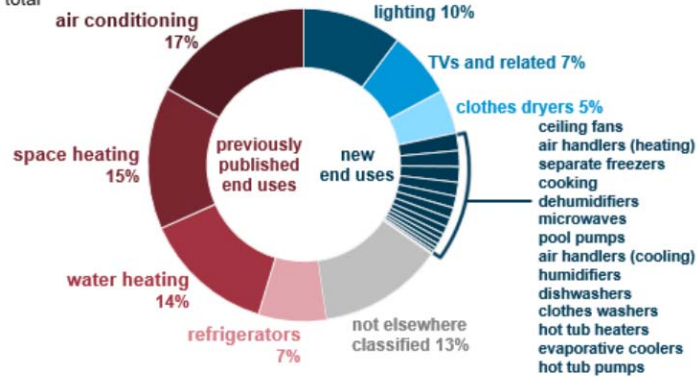

AC Usage Varies Greatly

U.S. average residential air-conditioning expenditures by climate region, 2015

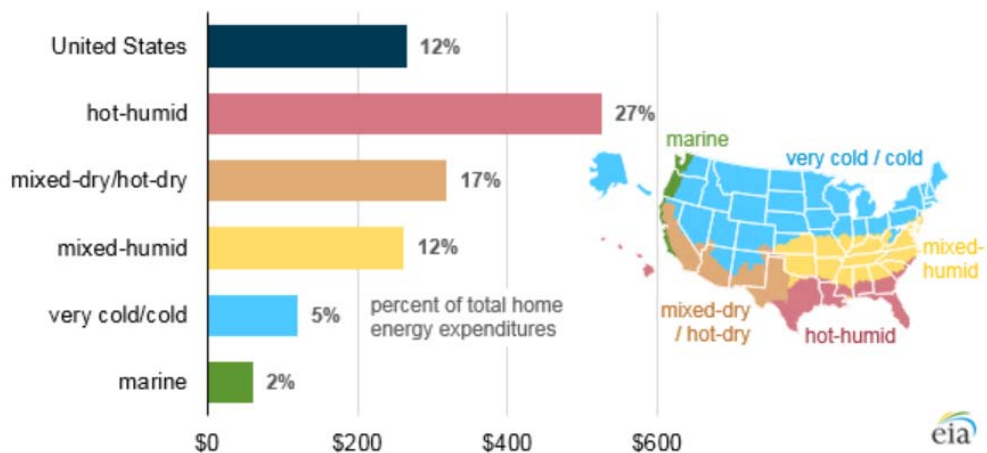

Mechanical systems

- Water heating & distribution
- Heating & Cooling
- Ventilation
- Lighting & Appliances



13

Codes: Applied building science

- Energy codes today are based on building science
- Some examples include 2015/18 IECC envelope & mechanical system requirements
- Some requirements are prescriptive while others are mandatory



14

IECC envelope examples



- Blower door testing was an option in 2009 IECC (< 7 ACH₅₀)
- For 2012/15/18 IECC, homes must pass mandatory air leakage testing (blower door)
 - Climate zones 1 & 2 must test at < 5 ACH₅₀
 - Climate zones 3 - 8 must test at < 3 ACH₅₀
- Homes must meet increased thermal boundary requirements (insulation, windows, etc.)
- Different pathways available to demonstrate compliance (e.g., prescriptive tables & REScheck)

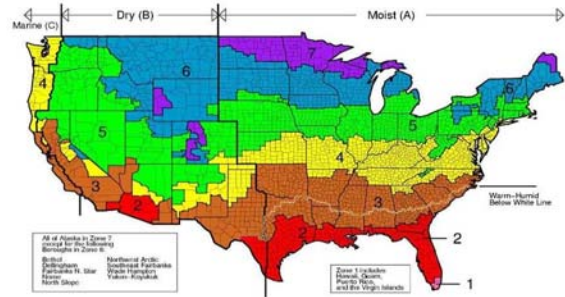

15

IECC mechanical examples



- Heating and cooling system ducts must be sealed and pass more stringent duct leakage testing (~4 cfm₂₅ / 100 s.f.)
- Mechanical ventilation systems are mandatory for < 5 ACH₅₀ (IRC 2012/15/18 & ASHRAE 62.2)
- Heating and cooling equipment must be properly sized and selected (Manual J & S)
- Equipment must meet minimum efficiency ratings (which are set by a separate DOE standard)
- Combustion safety issues are starting to be addressed



16

R403.7 Manual J & Manual S – Load Calculations and Equipment Selection

Winter Outdoor Design Temp

Load calcs are required, but there are no details about who is qualified to perform them

Summer Outdoor Design Temp

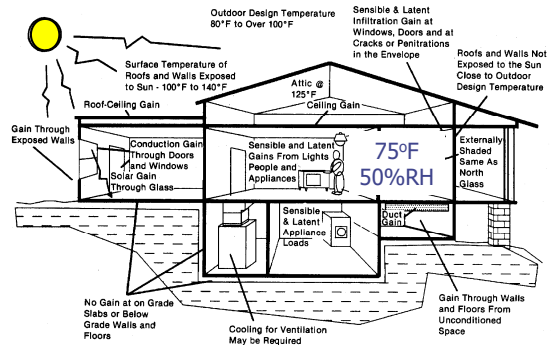
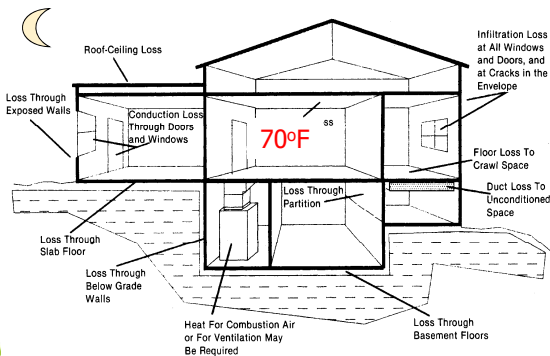

Energy codes

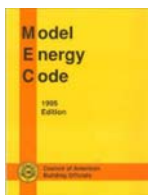

- A brief history of energy codes
- Overview of the 2015/18 IECC
- Compliance options – focus on the ERI



History of energy codes

- MEC 1992, '93, 95 – Early energy codes (complicated)
- IECC 98, 2000, '03 – Strengthening of codes
- IECC 2004, '06 – Codes become simpler
- IECC 2009 – Big jump in stringency, duct & envelope testing introduced, ARRA “mandated”
- IECC 2012 – Stricter testing & envelope requirements
- IECC 2015/18 - More stringent, new compliance path introduced (Energy Rating Index)
 - Historically, the code increased in stringency about 1-3% each cycle - until more recently!
 - '09 Code is ~15% more stringent than '06 version
 - '12 Code is ~30% more stringent than '06 version
 - '15, '18 Code is ~30+% more stringent than '06 version



19

Energy Code Trajectory

- Residential Energy Codes became much more stringent between IECC 2006 and 2012
- Since then, residential energy codes have been mostly stagnant

Improvement in Residential and Non-Residential Model Energy Codes (Year 1975-2015)

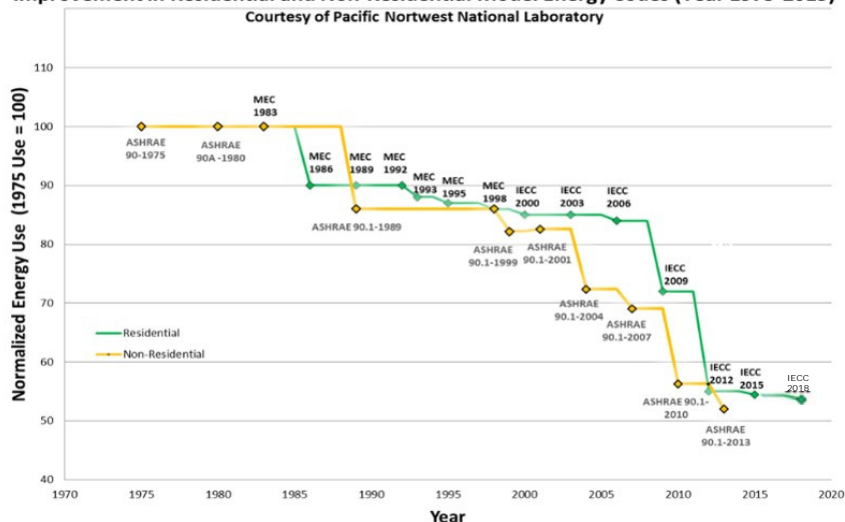

20

Energy Code Adoption by State – Mar 2020

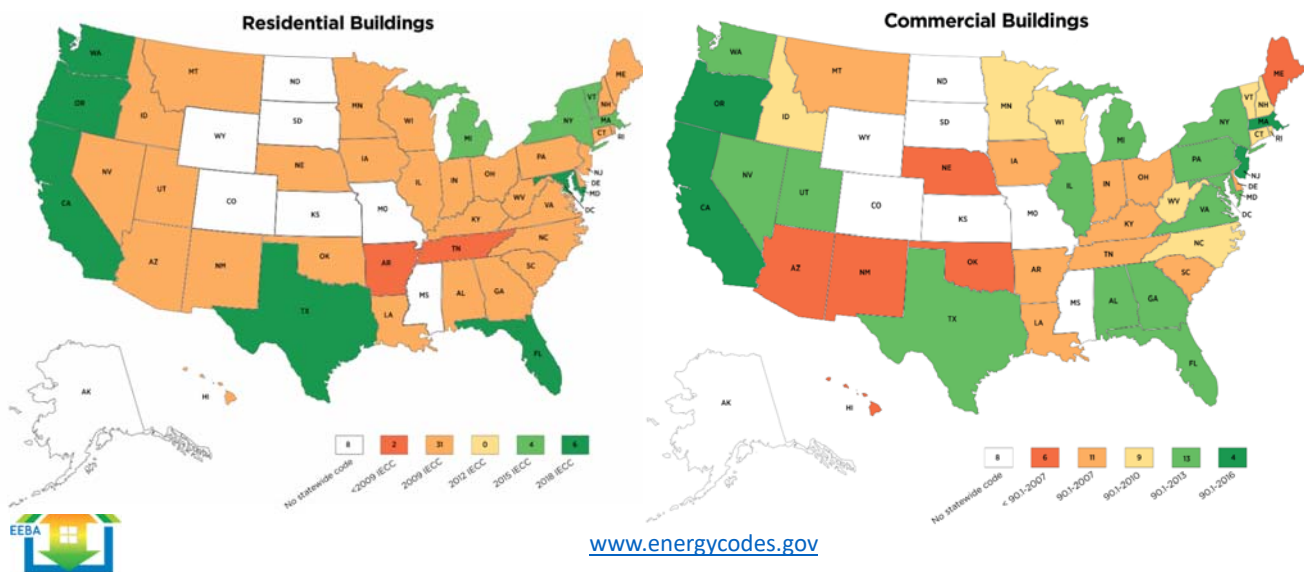

21

The 2015/18 IECC: Overview

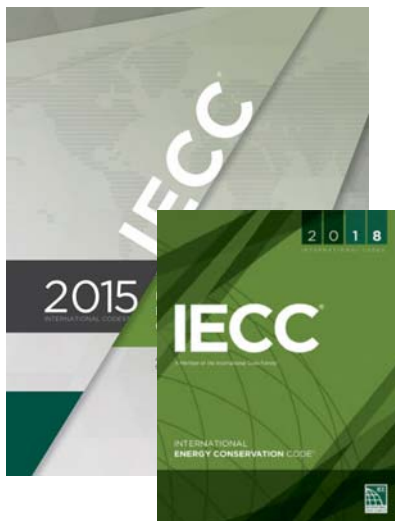

- What are the mandatory requirements of the 2015/18 IECC?
- Like previous versions, the 15/18 IECC provides prescriptive and trade-off performance options
- The 2015 IECC introduces a new compliance option: the Energy Rating Index (ERI)



22

Review: Thermal and Air Barriers

- The building envelope is comprised of thermal & pressure boundaries
- The thermal & pressure boundaries must be complete and aligned



- Insulation products such as fiberglass batts need to be completely enclosed on all sides
- Insulation is most effective when it is continuous and located on the exterior



23

Continuous Insulation & Air Barrier

- **Building Thermal Envelope** (air barrier and insulation must be in contact)

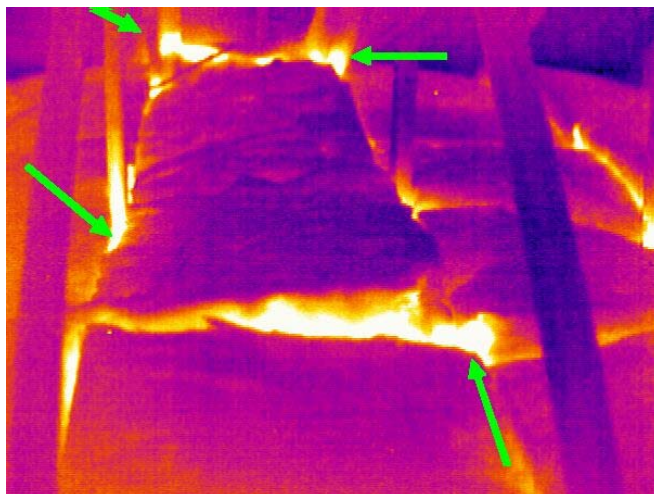

24

Thermal Boundary

- Limits heat transfer between inside and outside.
- Identified by the presence of insulation.
- The location of insulation in relation to other building components is critical to its effectiveness.
- Even small areas of missing insulation are very important.
- Voids of 7% can reduce effective R-value by half.

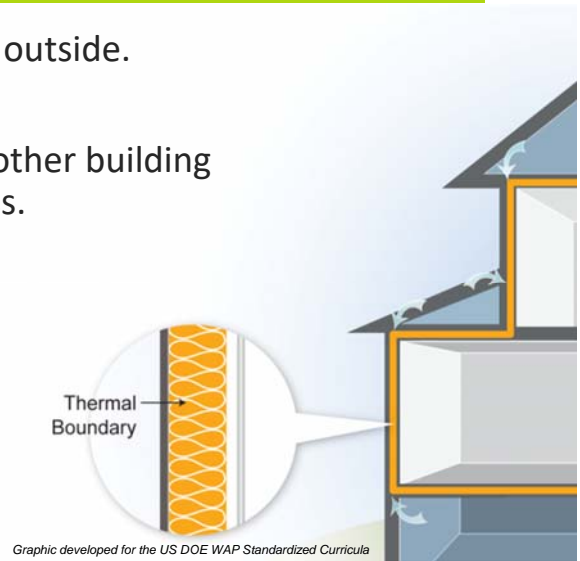

25

Building Thermal Envelope

Example 1

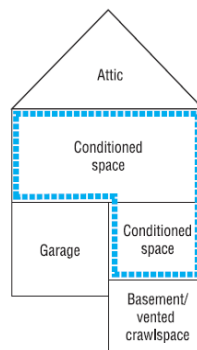

Example 2

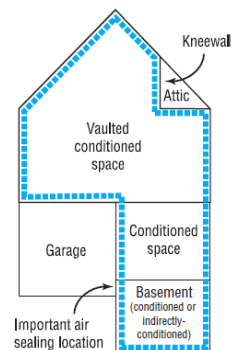

Example 3

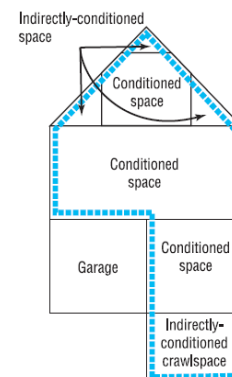

- Although these three homes look identical from the outside, each has defined the building thermal envelope differently



26

Conduction Heat Flow Calculations

- Heat transfer through a solid object: the formula for calculating transmission heat loss is:

$$q = U \times A \times \Delta T$$

- q = heat flow (Btu/hr)
- U = inverse of R-Value [$U=1/R$, $R=1/U$] (Btu/hr ft²°F)
U is referred to as the *Conductance* or *Thermal Transmittance*
- A = area (square feet)
- ΔT = temperature difference across component (°F)



Btu = British Thermal Unit



27

Insulation Coverage is key!

- If 990 s.f. of R-38 is installed with 10 s.f. of uninsulated attic access (R-1), it effectively yields the same heat transfer as R-28!

$$U_{\text{avg}} = \frac{U_1 \times A_1 + U_2 \times A_2 + U_3 \times A_3}{A_{\text{total}}}$$

$$U_{\text{avg}} = \frac{0.026 \times 990 + 1 \times 10}{1000}$$

$$U_{\text{avg}} = 0.036 \quad R = 27.7$$

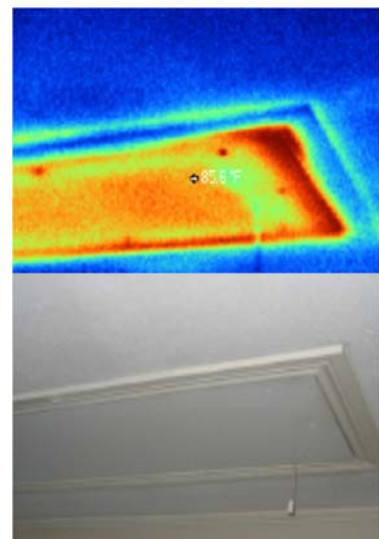

28

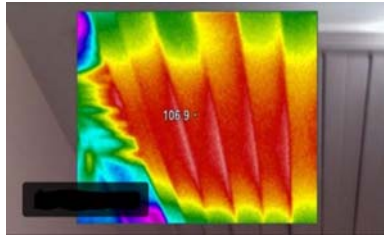

Insulation
Coverage is Key!



Prescriptive Code

The 2015/18 IECC: Prescriptive

INSULATION AND FENESTRATION REQUIREMENTS BY COMPONENT^a

CLIMATE ZONE	FENESTRATION U-FACTOR ^b	SKYLIGHT ^b U-FACTOR	GLAZED FENESTRATION SHGC ^{b, c}	CEILING R-VALUE	WOOD FRAME WALL R-VALUE	MASS WALL R-VALUE ^d	FLOOR R-VALUE	BASEMENT ^e WALL R-VALUE	SLAB ^d R-VALUE & DEPTH	CRAWL SPACE ^e WALL R-VALUE
1	NR	0.75	0.25	30	13	3/4	13	0	0	0
2	0.40	0.65	0.25	38	13	4/6	13	0	0	0
3	0.35 0.32	0.55	0.25	38	20 or 13+5 ^h	8/13	19	5/13 ^f	0	5/13
4 except Marine	0.35 0.32	0.55	0.40	49	20 or 13+5 ^h	8/13	19	10/13	10, 2 ft	10/13
5 and Marine 4	0.32 0.30	0.55	NR	49	20 or 13+5 ^h	13/17	30 ^g	15/19	10, 2 ft	15/19
6	0.32 0.30	0.55	NR	49	20+5 or 13+10 ^h	15/20	30 ^g	15/19	10, 4 ft	15/19
7 and 8	0.32 0.30	0.55	NR	49	20+5 or 13+10 ^h	19/21	38 ^g	15/19	10, 4 ft	15/19



Only changes
In 2018 code

Fill in the prescriptive code R-values

Determine Climate Zone

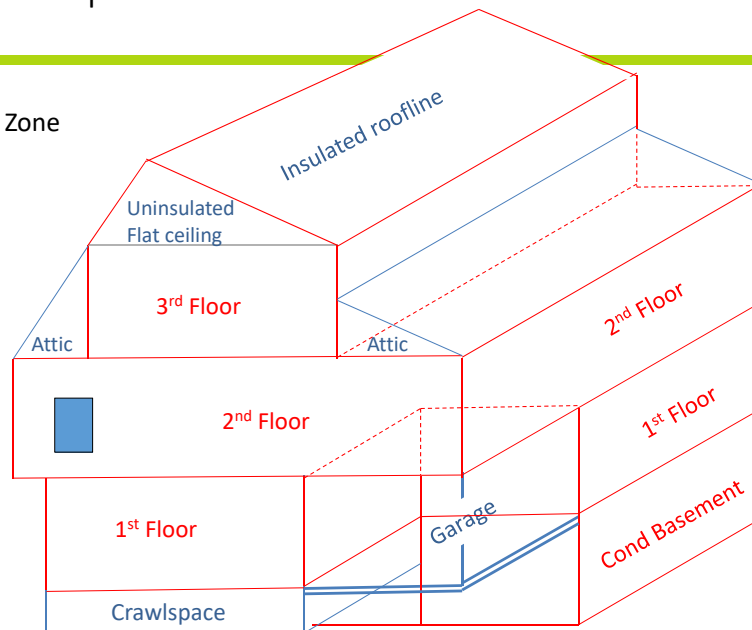

Prescriptive code R-values

Example: Climate Zone 4A

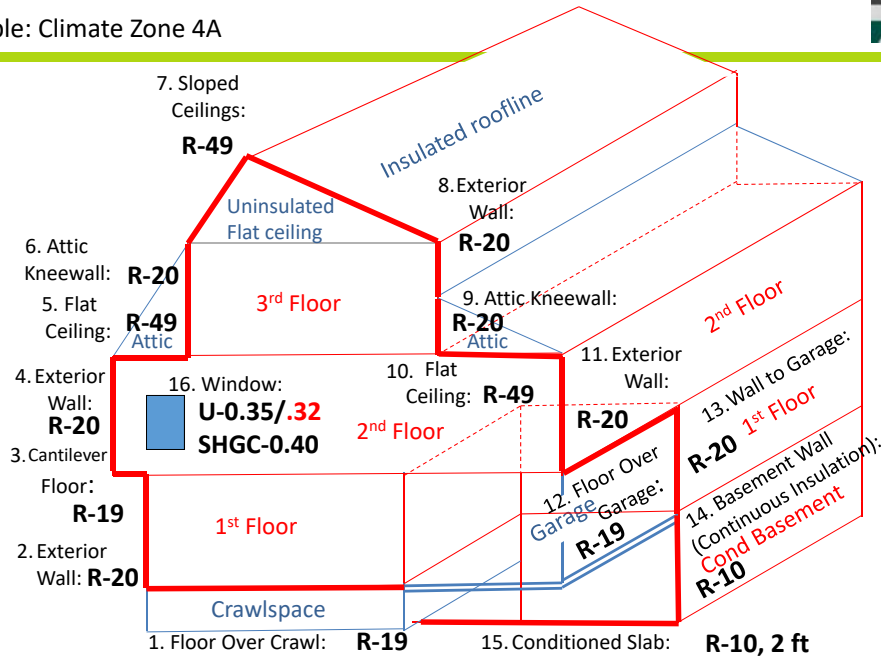

2015/18 IECC: R402.2

Specific Insulation Requirements (Prescriptive)



- R402.2.1 Ceilings with Attic Spaces
- R402.2.2 Ceilings without Attic Spaces
- R402.2.3 Eave Baffle
- R402.2.4 Access hatches and doors
- R402.2.5 Mass Walls
- R402.2.6 Steel Framing
- R402.2.7 Walls with Structural Sheathing
- R402.2.8 Floors
- R402.2.9 Basement Walls
- R402.2.10 Slab-on-grade floors
- R402.2.11 Crawlspace walls
- R402.2.12 Masonry Veneer
- R402.2.13 Sunrooms

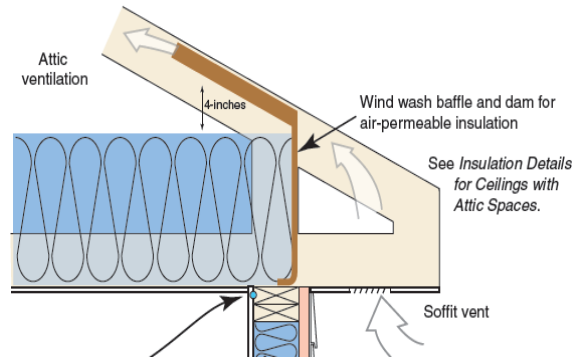

R402.2: SPECIFIC INSULATION REQUIREMENTS



Prescriptive details for insulating portions of the building envelope

- **Ceilings with Attic – 402.2.1**
- **Ceilings w/out Attic – 402.2.2**
- Eave baffles – 402.2.3
- Access hatches and doors – 402.2.4
- Mass Walls – 402.2.5
- Steel Framing – 402.2.6
- Partial structural sheathed walls – 402.2.7
- **Floors – 402.2.8**
- **Basement Walls – 402.2.9**
- Slab-on-grade – 402.2.10
- **Crawlspace Walls – 402.2.11**
- Masonry Veneer – 402.2.12
- Sunrooms – 402.2.13



38

402.2.1 - CEILINGS WITH ATTICS



- R-38 or 49 is typical prescriptive requirement
- Complete coverage of continuous R-30 or 38 is deemed to comply
- Rulers required every 300 s.f. for blown attic insulation (R301.1.1)



39

402.2.1 - CEILINGS WITH ATTICS

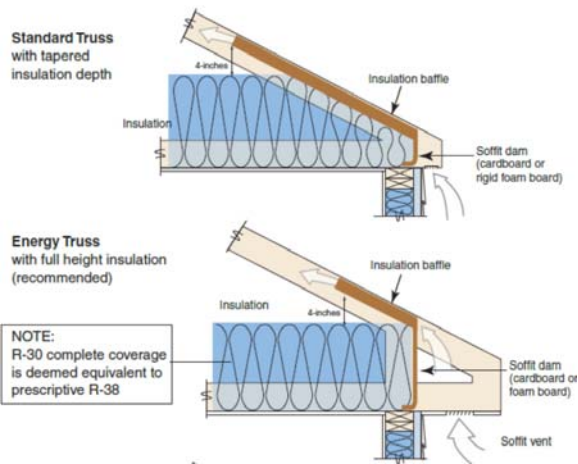

R402.2 Specific insulation requirements (Prescriptive). In addition to the requirements of Section R402.1, insulation shall meet the specific requirements of Sections R402.2.1 through R402.2.13.

R402.2.1 Ceilings with attic spaces. Where Section R402.1.2 would require R-38 insulation in the ceiling, installing R-30 over 100 percent of the ceiling area requiring insulation shall be deemed to satisfy the requirement for R-38 wherever the full height of uncompressed R-30 insulation extends over the wall top plate at the eaves. Similarly, where Section R402.1.2 would require R-49 insulation in the ceiling, installing R-38 over 100 percent of the ceiling area requiring insulation shall be deemed to satisfy the requirement for R-49 insulation wherever the full height of uncompressed R-38 insulation extends over the wall top plate at the eaves. This reduction shall not apply to the *U*-factor alternative approach in Section R402.1.4 and the total UA alternative in Section R402.1.5.



402.2.2 - CEILINGS WITHOUT ATTICS



- R-30 for 20% (up to 500 s.f.) acceptable
- Vaulted ceilings and foam sprayed rooflines will need to perform an R-value trade-off
- GA specific: Can trade down to unvented R-20 if spray foam insulation is used (air impermeable insulation)



Roofline Installed Insulation Options

Reference Table 402.1.1 and 402.1.6 in the Georgia Energy Code amendments to the 2015 IECC and Section 806.5 "unvented attic assemblies" in the Georgia Amendments to the 2012 IRC

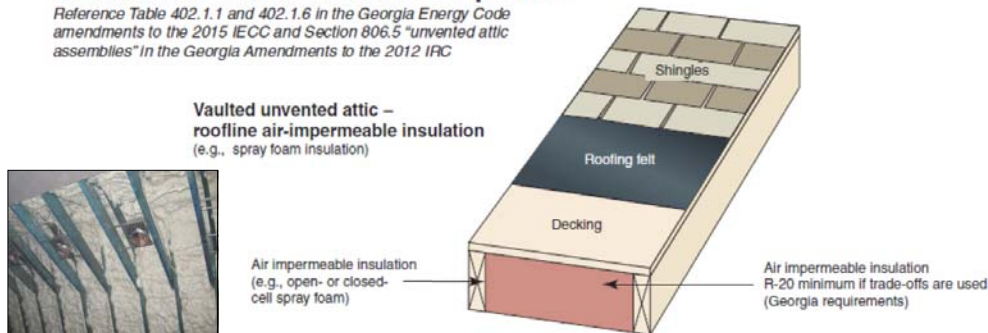

402.2.2 - CEILINGS WITHOUT ATTICS



- Can trade down to R-20 fiberglass or cellulose (air-permeable insulation) with added:
 - R-5 (CZ 2 & 3) or R-15 (CZ 4) rigid foam board (air impermeable insulation) for unvented attics

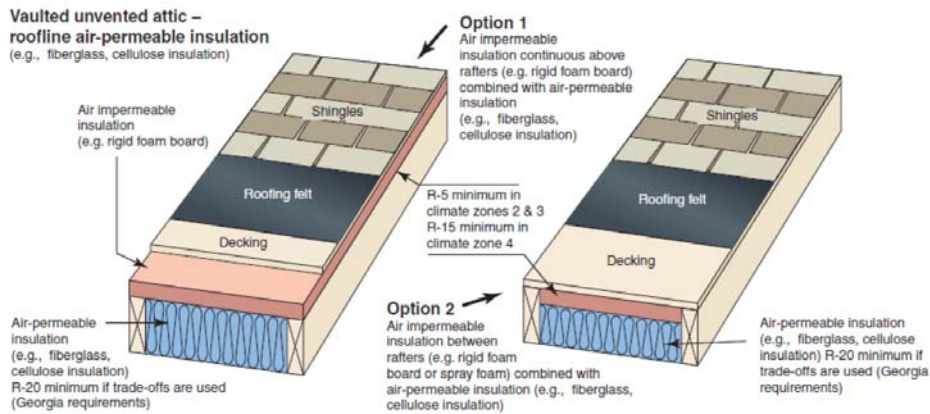

42

IRC 806.5 Unvented Roof Assemblies



- To reduce risk of condensation, install a certain amount of “air-impermeable” insulation before using an “air-permeable” product in an unvented roof assembly

TABLE R806.5
INSULATION FOR CONDENSATION CONTROL

CLIMATE ZONE	MINIMUM RIGID BOARD ON AIR-IMPERMEABLE INSULATION R-VALUE ^{a, b}
2B and 3B tile roof only	0 (none required)
1, 2A, 2B, 3A, 3B, 3C	R-5
4C	R-10
4A, 4B	R-15
5	R-20
6	R-25
7	R-30
8	R-35

a. Contributes to but does not supersede the requirements in Section N1102.

b. Alternatively, sufficient continuous insulation shall be installed directly above the structural roof sheathing to maintain the monthly average temperature of the underside of the structural roof sheathing above 45°F (7°C). For calculation purposes, an interior air temperature of 68°F (20°C) is assumed and the exterior air temperature is assumed to be the monthly average outside air temperature of the three coldest months.

5.3. Where preformed insulation board is used as the air-impermeable insulation layer, it shall be sealed at the perimeter of each individual sheet interior surface to form a continuous layer.



43

Case Study: Peachcrest Community Center



402.2.2 - CEILINGS WITHOUT ATTICS



- May trade down to R-20 fiberglass or cellulose (air-permeable insulation) with complete vented channel that extends to ridge

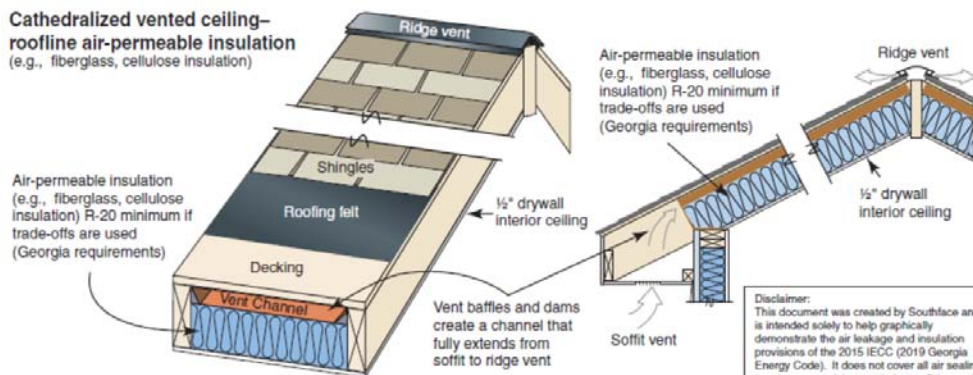

Georgia International Energy Conservation Code Supplements and Amendments 2019

Disclaimer: This document was created by Southface and is intended solely to help graphically demonstrate the air leakage and insulation provisions of the 2015 IECC (2019 Georgia Energy Code). It does not cover all air sealing locations, materials or techniques. Other code provisions may be applicable as well.



R402.2.8 FLOORS



R402.2.8 Floors. Floor framing-cavity insulation shall be installed to maintain permanent contact with the underside of the subfloor decking.

Exception: The floor framing-cavity insulation shall be permitted to be in contact with the topside of sheathing or continuous insulation installed on the bottom side of floor framing where combined with insulation that meets or exceeds the minimum wood frame wall *R*-value in Table 402.1.2 and that extends from the bottom to the top of all perimeter floor framing members.



47

R402.2.9 BASEMENT WALLS



R402.2.9 Basement walls. Walls associated with conditioned basements shall be insulated from the top of the *basement wall* down to 10 feet (3048 mm) below grade or to the basement floor, whichever is less. Walls associated with unconditioned basements shall meet this requirement unless the floor overhead is insulated in accordance with Sections R402.1.2 and R402.2.8.

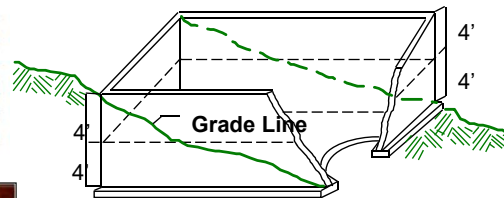

Basement Wall – Average gross wall must be > 50% below grade and enclose conditioned space

- CZ4C-8: R-15 continuous or R-19 cavity
- CZ4AB: R-10 continuous or R-13 cavity
- CZ3: R-5 continuous or R-13 cavity
- CZ1-2: No insulation required



48

R402.2.9 BASEMENT WALLS



Insulation strategies:

Cellulose batt



Fiberglass batt w/
vinyl backing



Rigid foam board



R402.2.9 BASEMENT WALLS



Insulation strategies:

Rigid
foam board



Fiberglass batt in
AGW, foam board
on concrete



Spray
Polyurethane
Foam



R402.2.9 BASEMENT WALLS



Blanket basement insulation options



51



R402.2.9 BASEMENT WALLS



Blanket basement insulation options



52



R402.2.11 CRAWLSPACE WALLS

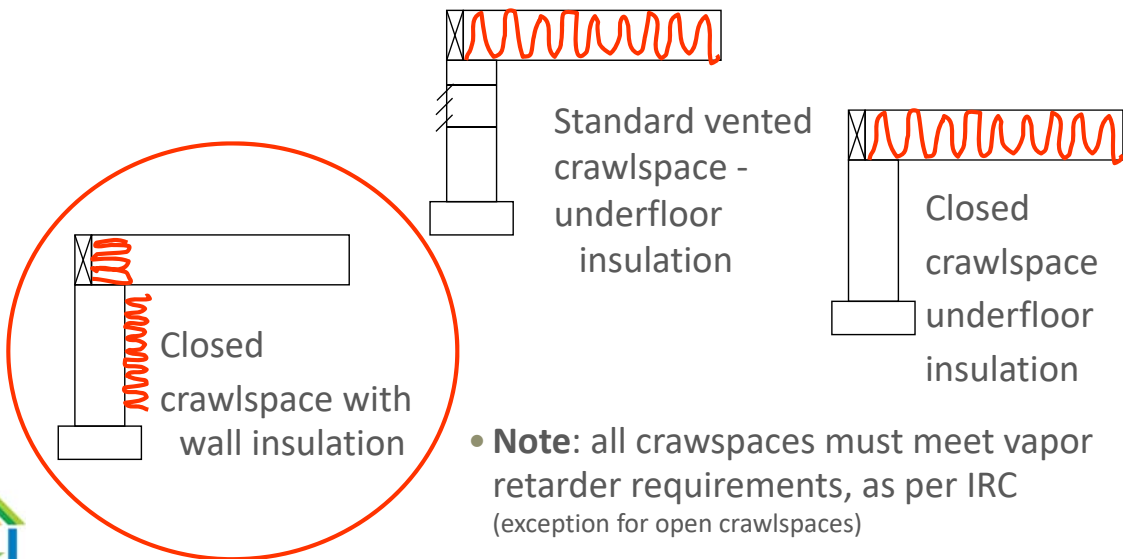

53

R402.2.11 CRAWLSPACE WALLS



- Seal ground with 6-mil plastic (6" up walls, 6" overlaps)
- Insulate interior of walls to satisfy code (aligns with basement R-values)
- Eliminate all vents and leaks (access doors)
- Satisfy IRC exception to vent requirement (IRC section R408.3)



Venting Exceptions:

- Continuous exhaust (radon)
- Direct condition crawlspace (supply)
- Direct condition (dehumidifier)



Critical Details:

- No drainage problems
- Use a sealed combustion / direct vent furnace or install a Heat Pump
- Pest Control and Code Official awareness



54

Crawl Insulation – Band area

Open/
Closed
Cell Foam



- Pest Control industry struggles with band area that is fully filled with SPF
- SPF that fills band blocks inspection for pest control
- Air seal and then insulate with movable insulation product (batts, pillows, rigid board, etc.)



Caulk and
Fiberglass Batt



Rigid
Foam
Board

- Must air seal and insulate rim/band area in basements & crawlspaces



Blown
Bag /
Pillow



SF suggestion: taped, hinged "plug" of rigid insulation board in gap

Gap for pest inspection

55

PROBLEMS WITH UNDERFLOOR INSULATION



- Learn the benefits of conditioned crawlspaces

www.crawlspaces.org

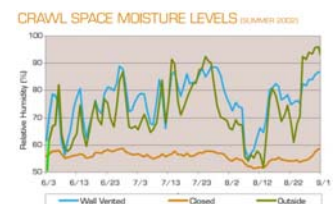

56

R402.3 FENESTRATION



U-factor

Lower U-factor means better insulated
($U = 1/R$)

U-factor applies to

- windows,
- skylights,
- doors

Solar Heat Gain Coefficient

The SHGC is the fraction of the solar heat from the sun that enters through a window

- SP clear glass
SHGC: ~ 0.8
- DP clear glass
SHGC: ~ 0.6-0.7
- DP low-e
(low solar gain)
SHGC: ~ 0.3

Single Pane

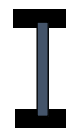

$U = 1.05$

Double Pane

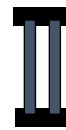

$U = 0.55$

Triple Pane



$U = 0.35$

Double Pane w/ low-e

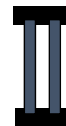

$U = 0.35$

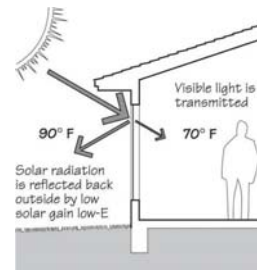

R402.3 FENESTRATION EXEMPTIONS



R402.3.3 Glazed fenestration exemption. Up to 15 square feet (1.4 m²) of glazed fenestration per dwelling unit shall be permitted to be exempt from U-factor and SHGC requirements in Section R402.1.2. This exemption shall not apply to the U-factor alternative approach in Section R402.1.4 and the Total UA alternative in Section R402.1.5.



R402.3.4 Opaque door exemption. One side-hinged opaque door assembly up to 24 square feet (2.22 m²) in area is exempted from the U-factor requirement in Section R402.1.4. This exemption shall not apply to Attic Access Doors or the U-factor alternative approach in Section R402.1.4 and the total UA alternative in Section R402.1.5. (Effective January 1, 2020)



2015/18 IECC Prescriptive Requirement – Hot water pipe insulation

R403.5.3 Hot water pipe insulation (Prescriptive). Insulation for hot water pipe with a minimum thermal resistance (R-value) of R-3 shall be applied to the following:

1. Piping $\frac{3}{4}$ inch (19.1 mm) and larger in nominal diameter.
2. Piping serving more than one dwelling unit.
3. Piping located outside the conditioned space.
4. Piping from the water heater to a distribution manifold.
5. Piping located under a floor slab.
6. Buried in piping.
7. Supply and return piping in recirculation systems other than demand recirculation systems.

- Insulation on all hot water pipes – smaller diameter best
- Centrally locate hot water source near fixtures (or point of use)
- Small diameter tubes to each fixture (“home run”)
(make sure manifold is very close to WH!)
- Recirculating systems – controls are critical
 - Timer
 - Demand (best!)

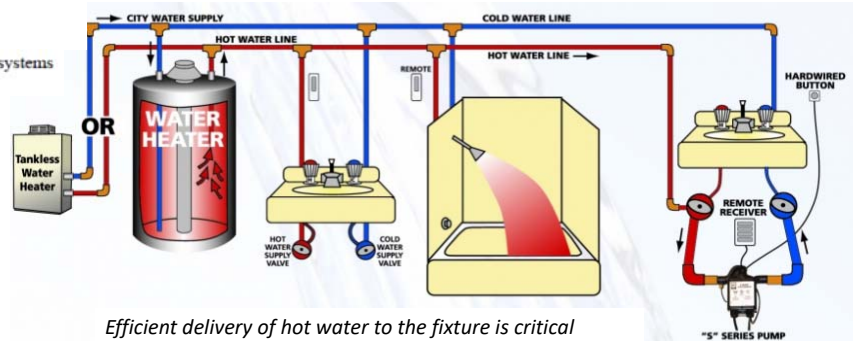

2015/18 IECC Mandatory Requirements

- R401.3 Certificate
- R402.4 Air leakage (air sealing, testing, fireplace, fenestration, combustion zones and recessed lighting specifics)
- R402.5 Maximum fenestration U-factor and SHGC
- R403.1 Controls
- R403.3.2-3 Duct sealing & testing
- R403.5.1 Hot water circulation & temperature maintenance systems
- R403.6 Mechanical ventilation
- R403.7 Equipment sizing and efficiency rating
- R403.8 Systems serving multiple dwelling units
- R403.9 Snow melt and ice system controls
- R403.11 Portable spas
- R404.1 Lighting equipment

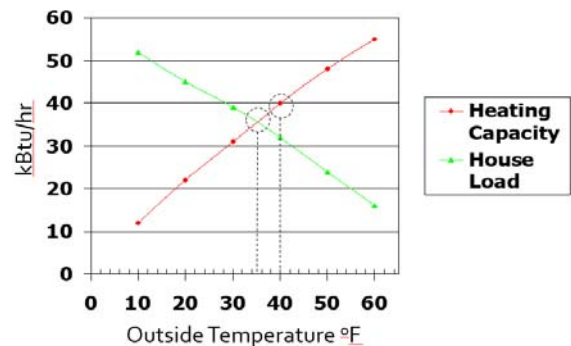

Air Barrier Installation

Building Science: Air Movement

- Air moves from high pressure to low
- $CFM_{out} = CFM_{in}$
- Air leakage requires
 - A hole or pathway
 - A pressure difference
- 3 forces cause pressure differences:
 - **Wind**
 - **Stack**
 - **Fans**



Air Barrier

- Limits airflow between inside and outside.
- The IECC defines the air barrier as materials assembled and joined together to limit air leakage.
- Should be collocated with the thermal boundary
- New homes – wall sheathing
Old homes – wall interior finish

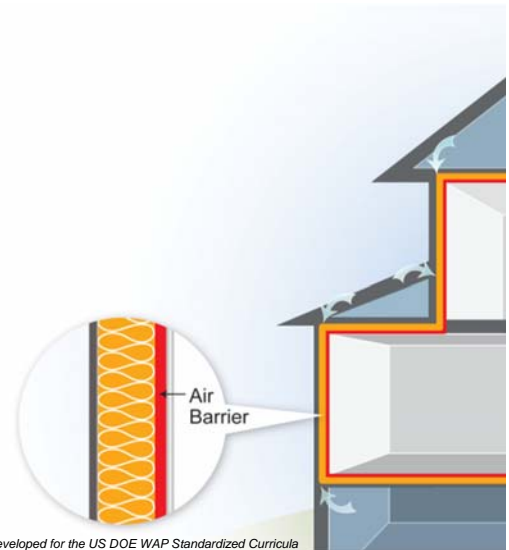

Graphic developed for the US DOE WAP Standardized Curricula



Major Air Leakage Locations - Residential

TABLE R402.4.1.1
AIR BARRIER AND INSULATION INSTALLATION*

COMPONENT	AIR BARRIER CRITERIA	INSULATION INSTALLATION CRITERIA
General requirements	A continuous air barrier shall be installed in the building envelope. The exterior thermal envelope contains a continuous air barrier. Breaks or joints in the air barrier shall be sealed.	Air-permeable insulation shall not be used as a sealing material.
Ceiling/attic	The air barrier in any dropped ceiling or soffit shall be aligned with the insulation and any gaps in the air barrier shall be sealed. Access openings, drop down stairs or knee wall doors to unconditioned attic spaces shall be sealed.	The insulation in any dropped ceiling/soffit shall be aligned with the air barrier.
Walls	The junction of the foundation and sill plate shall be sealed. The junction of the top plate and the top of exterior walls shall be sealed. Knee walls shall be sealed.	Cavities within corners and headers of frame walls shall be insulated by completely filling the cavity with a material having a thermal resistance, <i>R</i> -value, of not less than <i>R</i> -3 per inch. Exterior thermal envelope insulation for framed walls shall be installed in substantial contact and continuous alignment with the air barrier.
Windows, skylights and doors	The space between framing and skylights, and the jambs of windows and doors, shall be sealed.	—
Rim joists	Rim joists shall include the air barrier.	Rim joists shall be insulated.
Floors, including cantilevered floors and floors above garages	The air barrier shall be installed at any exposed edge of insulation.	Floor framing cavity insulation shall be installed to maintain permanent contact with the underside of subfloor decking. Alternatively, floor framing cavity insulation shall be in contact with the top side of sheathing, or continuous insulation installed on the underside of floor framing; and shall extend from the bottom to the top of all perimeter floor framing members.



Major Air Leakage Locations - Residential



Crawl space walls	Exposed earth in unvented crawl spaces shall be covered with a Class I vapor retarder with overlapping joints taped.	Crawl space insulation, where provided instead of floor insulation, shall be permanently attached to the walls.
Shafts, penetrations	Duct shafts, utility penetrations, and flue shafts opening to exterior or unconditioned space shall be sealed.	—
Narrow cavities	—	Batts to be installed in narrow cavities shall be cut to fit or narrow cavities shall be filled with insulation that on installation readily conforms to the available cavity space.
Garage separation	Air sealing shall be provided between the garage and conditioned spaces.	—
Recessed lighting	Recessed light fixtures installed in the building thermal envelope shall be sealed to the finished surface.	Recessed light fixtures installed in the building thermal envelope shall be air tight and IC rated.
Plumbing and wiring	—	In exterior walls, batt insulation shall be cut neatly to fit around wiring and plumbing, or insulation, that on installation readily conforms to available space, shall extend behind piping and wiring.
Shower/tub on exterior wall	The air barrier installed at exterior walls adjacent to showers and tubs shall separate the wall from the shower or tub.	Exterior walls adjacent to showers and tubs shall be insulated.
Electrical/phone box on exterior walls	The air barrier shall be installed behind electrical and communication boxes. Alternatively, air-sealed boxes shall be installed.	—
HVAC register boots	HVAC supply and return register boots that penetrate building thermal envelope shall be sealed to the subfloor, wall covering or ceiling penetrated by the boot.	—
Concealed sprinklers	Where required to be sealed, concealed fire sprinklers shall only be sealed in a manner that is recommended by the manufacturer. Caulking or other adhesive sealants shall not be used to fill voids between fire sprinkler cover plates and walls or ceilings.	—

a. Inspection of log walls shall be in accordance with the provisions of ICC 400.



Blower Door Recap

- For any given home, there is one unique amount of CFM that will create exactly 50 Pa difference across the envelope.

$$CFM_{50}$$

$$ACH_{50} = \frac{CFM_{50} \times 60}{Volume}$$

- Say a blower door is used to depressurize a house to -50 Pa,

While the fan is running, the water in a sink's P-trap will...

ANSWER: Water in trap will rise up 0.2" towards the house

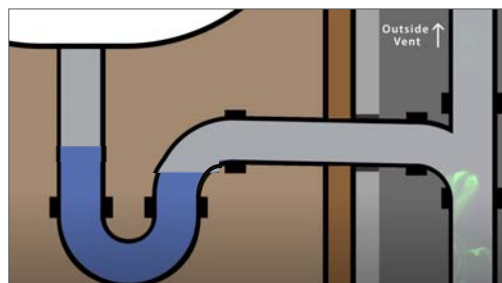

Residential Blower door testing



- Optional in 2009 IECC (<7 ACH₅₀),
Required by 2012 and later versions
- CZ 1-2 < 5 ACH₅₀
- CZ 3-8 < 3 ACH₅₀
- Quantifies the amount of leakage across the home's thermal boundary
- Several states - Test performed by a certified professional (DET Verifier, HERS Rater, BPI, etc.)
- Reported to builder and code official via certificate

$$ACH_{50} = \frac{CFM_{50} \times 60}{Volume}$$

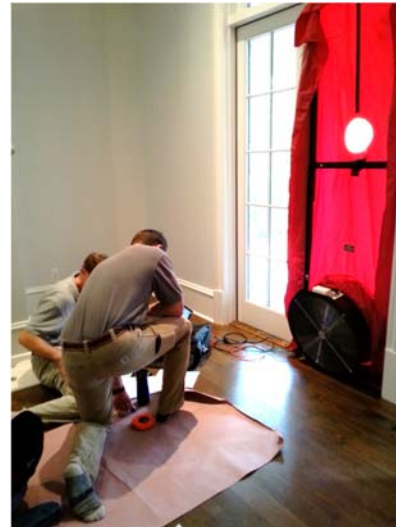

67

2012-18 IRC Ventilation requirements

- Ventilation is **REQUIRED**
- For any home tighter than 5 ACH50

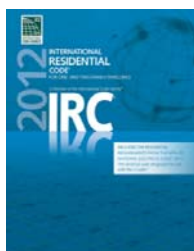

R303.4 Mechanical ventilation. Where the air infiltration rate of a dwelling unit is less than 5 air changes per hour when tested with a blower door at a pressure of 0.2 inch w.c (50 Pa) in accordance with Section N1102.4.1.2, the dwelling unit shall be provided with whole-house mechanical ventilation in accordance with Section M1507.3.

R303.5 Opening location. Outdoor intake and exhaust openings shall be located in accordance with Sections R303.5.1 and R303.5.2.

R303.5.1 Intake openings. Mechanical and gravity outdoor air intake openings shall be located a minimum of 10 feet (3048 mm) from any hazardous or noxious contaminant, such as vents, chimneys, plumbing vents, streets, alleys, parking lots and loading docks, except as otherwise specified in this code. Where a source of contaminant is located within 10 feet (3048 mm) of an intake opening, such opening shall be located a minimum of 3 feet (914 mm) below the contaminant source.

For the purpose of this section, the exhaust from *dwelling unit* toilet rooms, bathrooms and kitchens shall not be considered as hazardous or noxious.

R303.5.2 Exhaust openings. Exhaust air shall not be directed onto walkways.



68

R403.6 – 2012-18 IECC Ventilation requirements

- Ventilation is **REQUIRED**:
- For most of country (CZ 3-8), < **3 ACH₅₀**
- For CZ 1-2, < **5 ACH₅₀**

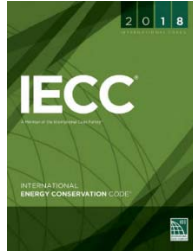

Between '12 IECC and '12 IRC, whole house mechanical ventilation is now mandated everywhere!



R403.6 Mechanical ventilation (Mandatory). The building shall be provided with ventilation that complies with the requirements of the *International Residential Code* or *International Mechanical Code*, as applicable, or with other approved means of ventilation. Outdoor air intakes and exhausts shall have automatic or gravity dampers that close when the ventilation system is not operating.

R403.6.1 Whole-house mechanical ventilation system fan efficacy. Fans used to provide whole-house mechanical ventilation shall meet the efficacy requirements of Table R403.6.1.

Exception: Where an air handler that is integral to tested and *listed* HVAC equipment is used to provide whole-house mechanical ventilation, the air handler shall be powered by an electronically commutated motor.

69

R404.1 Efficient Lighting



9 bulbs x 60 watts each = 540 w
 540 w x 4 hours a day = 2160 wh
 2160 wh x 365 days = 788,400 wh a year
 788,400 / 1000 = 788 kwh
 788 kwh x \$.12 = \$94.61 per year

9 bulbs x 9 watts each = 81 w
 81 w x 4 hours a day = 324 wh
 324 wh x 365 days = 118,260 wh a year
 118,260 / 1000 = 118 kwh
 118 kwh x \$.12 = \$14.19 per year



High Efficacy Lamps Thresholds
 2009 IECC ≥ 50%
 2015 IECC ≥ 75%
 2018 IECC ≥ 90%



70

Economics of Lighting for Builders



Bulb Cost Assumption:		Electricity Rate: 0.12 \$/kwh			
Incandescent = \$0.25					
LED = \$2 each					
	# Incand	# LED's	Price Premium	Bulb Wattage	
				Incand	LED
All Incand House	60	0	\$ -	60	10
50% LED House	30	30	\$ 52.50	60	10
100% LED House	0	60	\$ 105.00	60	10

It takes 24 days to payback LED's if half the lights are left on during construction!
(12 days if all on!!!)



	\$ Cost for 1 month - ON half the time			Simple Payback	
	Incand	LED	Total	\$ Savings (months)	(days)
100% Incand House	\$ 158.11	\$ -	\$ 158.11	0	
50% Incand / 50% LED	\$ 79.06	\$ 13.18	\$ 92.23	\$ 65.88	0.80 24.3
100% LED House	\$ -	\$ 26.35	\$ 26.35	\$ 131.76	0.80 24.3

Compliance Options

2015/18 IECC compliance options



- Prescriptive (table)
- Total UA Alternative (REScheck)
- Simulated Performance Alternative (computer simulation using the *standard reference and proposed design*)
- Energy Rating Index (“HERS Rating”)

73

COMPLIANCE PATHS FOR INSULATION & WINDOWS

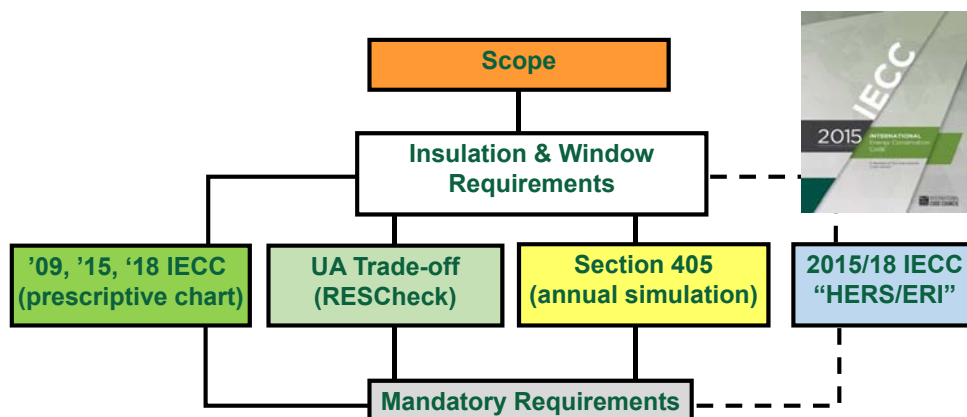

- The new ERI path gives the most design flexibility – such as credit for mechanical equipment efficiency
- It also credits items not covered by the code (e.g., appliance efficiencies)



74

RESCHECK FOR UA TRADEOFF



- www.energycodes.gov
- Software evaluates specific designs quickly
- Demonstrates SHGC compliance
- Allows trade-offs
 - Building envelope components
 - No trade-offs for better heating & cooling equipment efficiencies

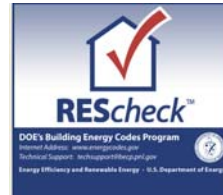

75



2015 IECC – Section 405 Simulated Performance Alternative



- Annual energy usage simulation demonstrates that the proposed building's energy costs are \leq "standard code" building
- No credit for mechanical efficiencies
- Likely to involve a HERS rater
- Ekotrope, REMrate & Energy Gauge are acceptable
- REScheck has a "crude" version



www.resnet.us



76

2015 IECC – Section 405

Simulated Performance Alternative – Sample Report



- **Compares total annual energy costs**

- ❑ Window U-factor and SHGC
- ❑ Envelope and duct testing
- ❑ Lighting, duct insulation

SIMULATED PERFORMANCE ALTERNATIVE - 2015 IECC ANNUAL ENERGY COST COMPLIANCE

IECC 2015 Performance Compliance

Property 123 Fake Street Savannah, GA 31302	Organization Southface Training Southface Trainer	Inspection Status Results are projected
Approved to pass 2015 IECC ACME ACME# 148	Builder Wiley E. Coyote	

	IECC 2015 Performance	As Designed
Annual Energy Cost		
Design		
Heating	\$1,211	\$695
Cooling	\$414	\$387
Water Heating	\$392	\$311
Sub Total - Used to determine compliance	\$1,997	\$1,452
Lights & Appliances	\$505	\$505
Credits generation	\$0	\$0
Total	\$2,803	\$2,259

Requirements	
405.3	Performance-based compliance passes by 27.2%
402.4.1.2	Air Leakage Testing: Air sealing is 5.05 ACH at 50 Pa. It must not exceed 5.00 ACH at 50 Pa.
402.5	Area-weighted average fenestration SHGC
402.5	Area-weighted average fenestration U-Factor
404	Lighting Equipment Efficiency
403.1.1	Mechanical Ventilation Efficiency
Mandatory Checks	Mandatory code requirements that are not checked by Extrage must be met
405.2	Duct Insulation

Design exceeds requirements for IECC 2015 Performance compliance by 27.2%.

All a 3rd party extension of the code jurisdiction utilizing these reports, I certify that this energy code compliance document has been created in accordance with the requirements of Chapter 4 of the adopted International Energy Conservation Code based on Climate Zone 2. If rating is Projected, I certify that the building design described herein is consistent with the building plans, specifications, and other calculations submitted with the permit application. If rating is Confirmed, I certify that the address referenced above has been inspected and that the construction of the building complies with the code as amended through the date of this report.

- **Compares energy costs of actual home being built against 2015 IECC reference home's energy cost**



The Energy Rating Index (ERI) path

The ERI may allow more options in materials choice, technologies and innovative strategies than the simulated performance path



- The new Energy Rating Index (ERI) path gives the most design flexibility (e.g., credit for mechanical equipment efficiency)
- It also credits items not covered by the code (e.g., appliance efficiencies)



Determining the Energy Rating Index



1. Simulate two homes

- **Rated** Home – what will be built
- **Reference** Home – same home but exactly meets '06 code

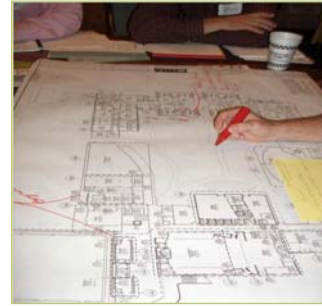

2. Compare Annual Energy

- Space Heating & Cooling, Hot Water, Lighting and some Appliances
- Multiply by 100 (lower w/ renewables)

40 30 30 50

$$\text{Index} = 100 \times PE_{\text{fraction}} \times \frac{[\text{Rated Home's Htg} + \text{Clg} + \text{WtrH} + \text{L.A.}]}{[\text{Refer. Home's Htg} + \text{Clg} + \text{WtrH} + \text{L.A.}]} = 75$$

70 20 30 80



79

ERI Target Values



- The 2015/18 IECC sets a maximum ERI for each climate zone
- The ERI is not a “magic bullet” or “easy cakewalk”
- However, it opens more options and allows builders more credit for innovative strategies (“the ERI shall consider all energy used in the residential building”)



TABLE R406.4
MAXIMUM ENERGY RATING INDEX

CLIMATE ZONE	ENERGY RATING INDEX	ENERGY RATING INDEX*
1	52	57
2	52	57
3	51	57
4	54	62
5	55	61
6	54	61
7	53	58
8	53	58



The rated design must have an ERI less than or equal to the above table to comply with 2015/18 IECC

NOTE: The 2018 calculations were adjusted so the thresholds were amended!



81

Question 3: Likely Energy Code Compliance Scenarios

1. Builder A has a few small windows that don't quite meet code but their walls are sheathed with higher R-value than minimum.
2. Builder B just wants a construction package that will guarantee they comply every time
3. Builder C is incorporating high efficiency mini-split HP's, electric HP water heaters and is considering renewables; they want to foam the roofline to less than prescriptive and market the performance
4. Builder D is using standard equipment and appliances, tight construction and better windows, and wants to foam the roofline to less than prescriptive.

Answer choices:

1. **Prescriptive** ("Recipe")
2. **UA Trade-off** (REScheck)
3. **Simulated Perf** (Hourly sim.)
4. **Energy Rating Index** (ERI)



82

Energy Code Questions 4



According to the 2015/18 IECC, new homes are required to be tight and have mechanical whole-house ventilation systems.

- True
- False



83

Energy Code Questions 5



“A builder may choose to insulate the floor over a crawlspace or the walls of a conditioned crawlspace. For a basement, the only option is to insulate the floor over the basement.”

- True
- False



84

Energy Code Questions 6



What is the minimum percentage of high-efficacy lighting required by the 2015 IECC?

- 50%
- 75%
- 90%
- 100%

What is the minimum percentage of high-efficacy lighting required by the 2018 IECC?

- 50%
- 75%
- 90%
- 100%



85

Thoughts / Questions?



- [June 4: It All Begins with Building Science](#)
- [June 11: Cracking the Building Energy Code](#)
- [June 18: Demystifying Energy Modeling](#)
- [June 25: Healthy Homes Matter - Understanding IAQ & Ventilation](#)
- [July 2: An Industry That Puts It All Together: The World of HERS Raters](#)



www.eeba.org

- aaron@eeba.org

Thank you!

mikeb@southface.org



Southface Applied BS Webinars
Third Thursdays! 11 a.m. ET

- **June 18th** - Combustion Safety
- **July 16th** - HVAC Load Calcs
- **Aug 20th** - High Performance Design

www.southface.org

- mikeb@southface.org